

MX-5004MZF

4x1 HDMI 2.0a Quad-View Video Processor
with 4K2K60 4:4:4

User Manual



rev: 160727
Made in Taiwan



Safety and Notice

The **MX-5004MZF 4x1 HDMI 2.0a Quad-View Video Processor with 4K2K60 4:4:4** has been tested for conformance to safety regulations and requirements, and has been certified for international use. However, like all electronic equipment, the **MX-5004MZF** should be used with care. Please read and follow the safety instructions to protect yourself from possible injury and to minimize the risk of damage to the unit.

- Follow all instructions and warnings marked on this unit.
- Do not attempt to service this unit yourself, except where explained in this manual.
- Provide proper ventilation and air circulation and do not use near water.
- Keep objects that might damage the device and assure that the placement of this unit is on a stable surface.
- Use only the power adapter and power cords and connection cables designed for this unit.
- Do not use liquid or aerosol cleaners to clean this unit. Always unplug the power to the device before cleaning.



TABLE OF CONTENTS

INTRODUCTION.....	1
FEATURES.....	1
PACKAGE CONTENTS	1
SPECIFICATIONS	2
HARDWARE INSTALLATION.....	3
CONNECTION DIAGRAM	3
PANEL DESCRIPTIONS.....	4
OPERATION APPROACH	5
WARRANTY	16

INTRODUCTION

The **MX-5004MZF 4x1 HDMI 2.0a Quad-View Video Processor with 4K2K60 4:4:4** provides the most flexible and cost effective solution in the market to route high definition video source from any of the four FHD HDMI sources to the remote display at the same time. This solution is well suited for use in digital signage, conference room presentation systems or other similar settings or applications.

With up to 4K2K60 4:4:4 output resolution, users can display the mixed video with improved presentation quality. In the meantime, the unit can be controlled thru the popular serial port and Ethernet port to provide the most flexible control way to fit into any applications.

FEATURES

- 4x HDMI inputs and 1x HDMI output
- Input resolution supports from 640x480 to 1920x1200, interlaced or progressive
- Output resolution supports up to 4K2K@60Hz (4:4:4 8bits)
- Adjustable size & position through software
- Supports HDCP 1.4 compliant
- Firmware upgradable for support of new features and technology enhancements
- Titles, borders and colored backgrounds
- Resize, position, zoom & pan and blend output video
- Perfect as a video converter and a video switcher
- Software control through RS-232 and Ethernet
- Supports IR remote control
- Supports one input rotation
- Supports Pixel by Pixel mapping under 2x2 configuration

PACKAGE CONTENTS

- 1x MX-5004MZF
- 1x DC 12V 5A
- 1x Installation software CD
- 1x User Manual
- 1x IR Remote control (28 keys)
- 1x IR Receiving cable

SPECIFICATIONS

Model Name	MX-5004MZF	
Technical		
Role of usage	Multiplexer / video processor	
Background picture update	Yes	
HDCP compliance	1.4	
HDMI compliance	Input: HDMI 1.4 Output: HDMI 2.0a	
Video bandwidth	Input: HDMI [2.25G to 6.75Gbps] Output: Single-link 600MHz [18Gbps]	
Output Video Support	Up to 4K2K@60 (4:4:4 8bits)	
Input Video Support	Up to 1920x1200@60	
Video Format Support	Up to HDMI 2.0	
Audio support	Bypass	
Control	RS-232/ IP Control/ Front Panel	
Embedded video mixer	Yes	
Input TMDS signal	1.2 Volts [peak to peak]	
ESD protection	Human body model — ±15kV [air-gap discharge] & ±8kV [contact discharge]	
Input	4x HDMI + 1xRS-232 + 1x RJ-45(Ethernet)	
Output	1x HDMI	
HDMI connector	Type A [19-pin female]	
RS-232 connector	DE-9 [9-pin D-sub female]	
RJ-45 connector	WE/SS 8P8C	
Mechanical		
Housing	Metal enclosure	
Dimensions (L x W x H)	Model	390 x 224 x 42mm [1'3" x 8.8" x 1.6"]
	Package	526 x 318 x 156mm [1'7" x 12.5" x 6.1"]
	Carton	543 x 335 x 344mm [1'8" x 13.2" x 1'1"]
Weight	Model	2.3 kg [5.2 lbs]
Power supply	12V 5A DC	
Power Consumption	8.9 Watts [max]	
Operation temperature	0~40°C [32~104°F]	
Storage temperature	-20~60°C [-4~140°F]	
Relative humidity	20~90% RH [no condensation]	

HARDWARE INSTALLATION

MX-5004MZF as master

1. Connect all sources to HDMI Inputs on the MX-5004MZF.
2. Connect the display to HDMI Output on the MX-5004MZF.
3. Connect the +12V 5A DC power supply to the MX-5004MZF.

CONNECTION DIAGRAM

→ CAT5/5e/6 → HDMI → RS-232 → AUDIO

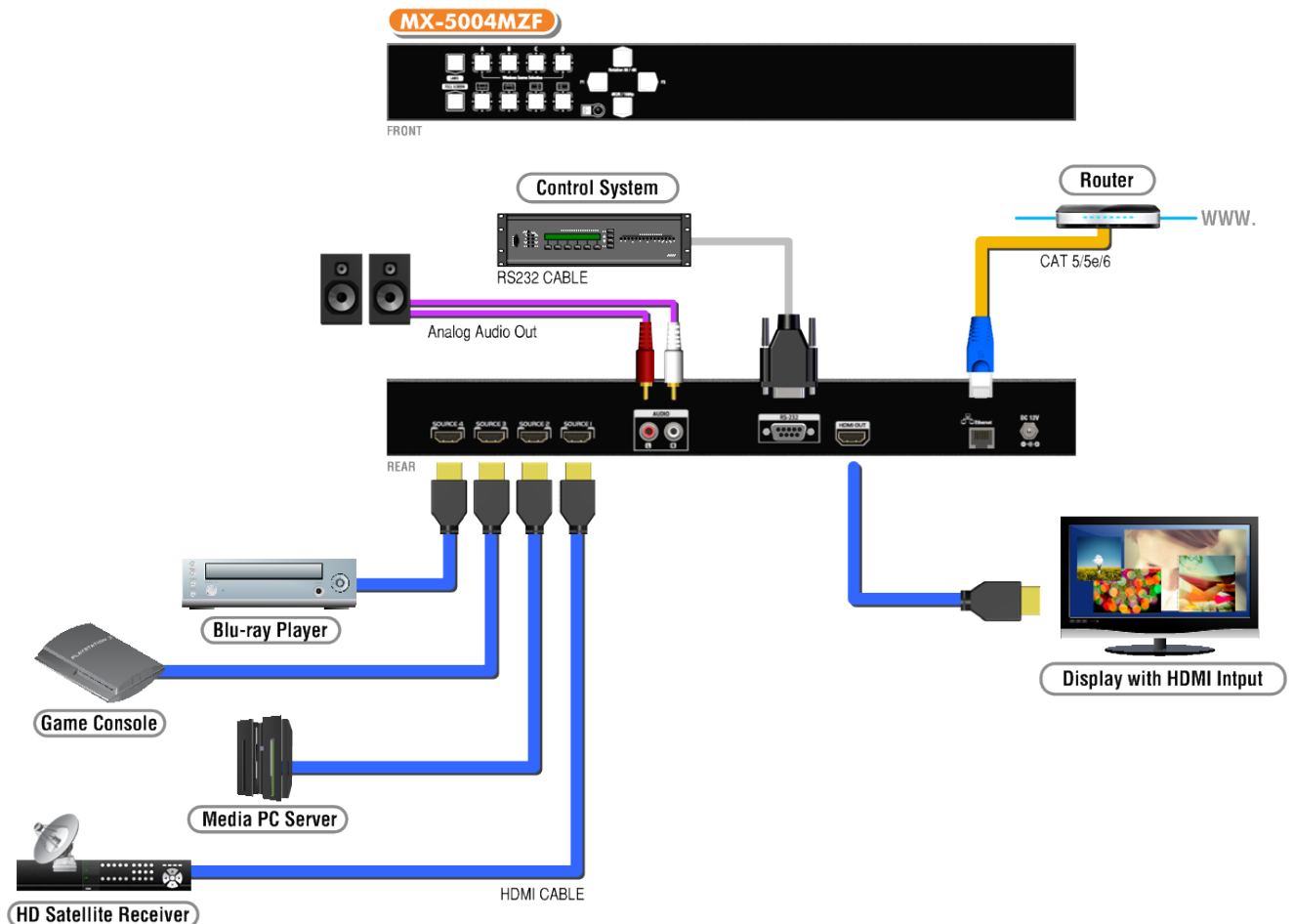

PANEL DESCRIPTIONS

MX-5004MZF

Front Panel

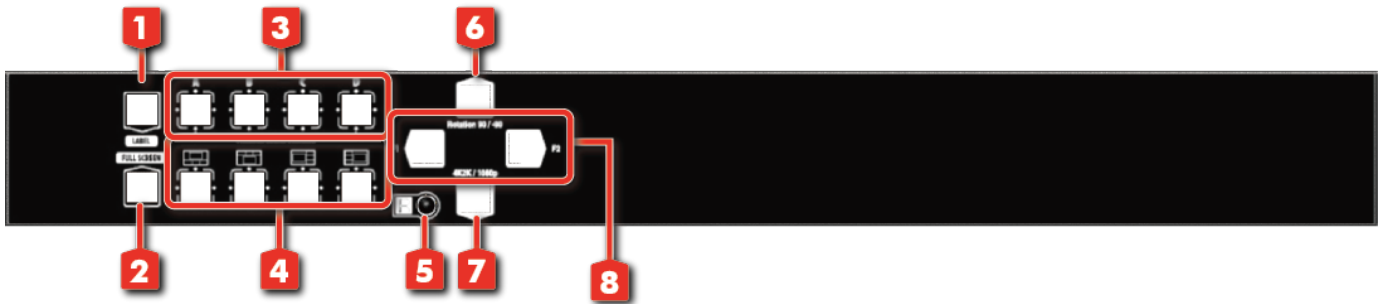

1. **LABEL:** All Windows label on/off
2. **FULL SCREEN:** Switch Window in full screen mode
3. **Windows Source Selection A-D:** Window A-D source selection
4. **Default Layout PAP:** Four different default layout PAP mode
5. **IR SENSOR:** IR sensor for receiving the IR commands from IR remote
6. **Rotation:** Window A rotate 90° or -90°
7. **4K2K / 1080p:** Switch output resolution in 4K2K@60 / 1080p
8. **F1 & F2:** Reserved

Rear Panel

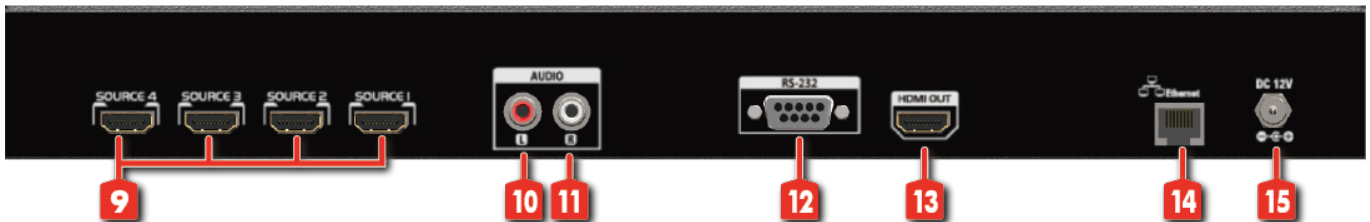



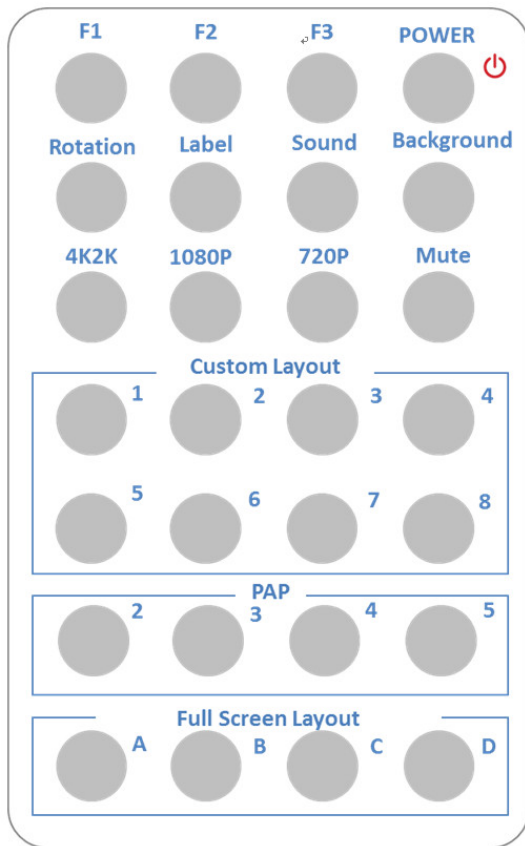

9. **SOURCE 1-4:** HDMI inputs
10. **Stereo audio output - L**
11. **Stereo audio output - R**
12. **RS-232:** RS-232 control port
13. **OUTPUT:** HDMI output
14. **Ethernet:** Ethernet control port
15. **+12V DC:** 12V DC power jack

OPERATION APPROACH

Method A: IR Remote Control



Button	Function
F1	HDMI/DVI mode switch
F2	Reserved
F3	Reserved
	Power on/off the device
Rotation	Window A rotate 90° or -90°
Label	Window label on/off
Sound	Fast Switch output's audio channel
Background	To set up the background picture of window
4K2K	Select 4K2K output resolution
1080P	Select 1080P@60 output resolution
720P	Select 720P@60 output resolution
Mute	Mute the audio output
Custom layout 1	Custom layout 1
Custom layout 2	Custom layout 2
Custom layout 3	Custom layout 3
Custom layout 4	Custom layout 4
Custom layout 5	Custom layout 5
Custom layout 6	Custom layout 6
Custom layout 7	Custom layout 7
Custom layout 8	Custom layout 8
PAP 2	Default layout PAP 
PAP 3	Default layout PAP 
PAP 4	Default layout PAP 
PAP 5	Default layout PAP 
Full screen layout A	Window A in full screen
Full screen layout B	Window B in full screen
Full screen layout C	Window C in full screen
Full screen layout D	Window D in full screen

Method B: Software Control through RS-232 port / Ethernet port

System Requirement and Precautions

1. Whenever power off MX-5004MZF, please stay unpowered at least 5 to 10 seconds to allow power capacitors to discharge.
2. The MX-5004MZF provides software control program which runs under Microsoft Windows 98, 2000, XP, 7, 8 through the interface of RS-232 serial control.
3. Before clicking on the icon of the software, make sure you have secured the connection between your computer COM port and the MX-5004MZF.

Start the software control program

When clicking on the executable file, the following dialog will pop-up. There are two ways to control the MX-5004MZF device (under Microsoft Windows 7, please run as administrator).

RS-232 serial Mode: Use RS-232 to connect the port on device and computer. Select correct COM port and click the OK button.

Ethernet Mode: Enter the IP address of the device and click the OK button.

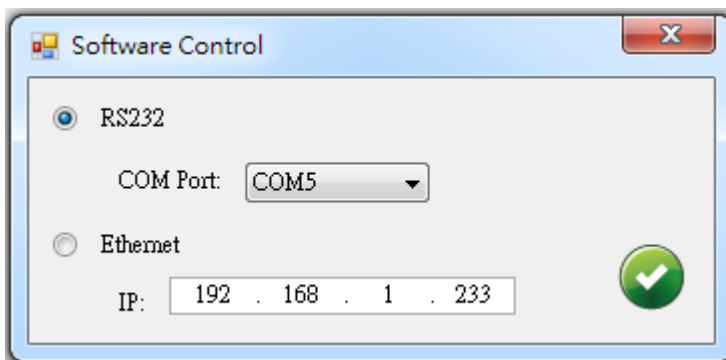

After the software control setting is accomplished, it will enter directly to control interface.

Control Interface

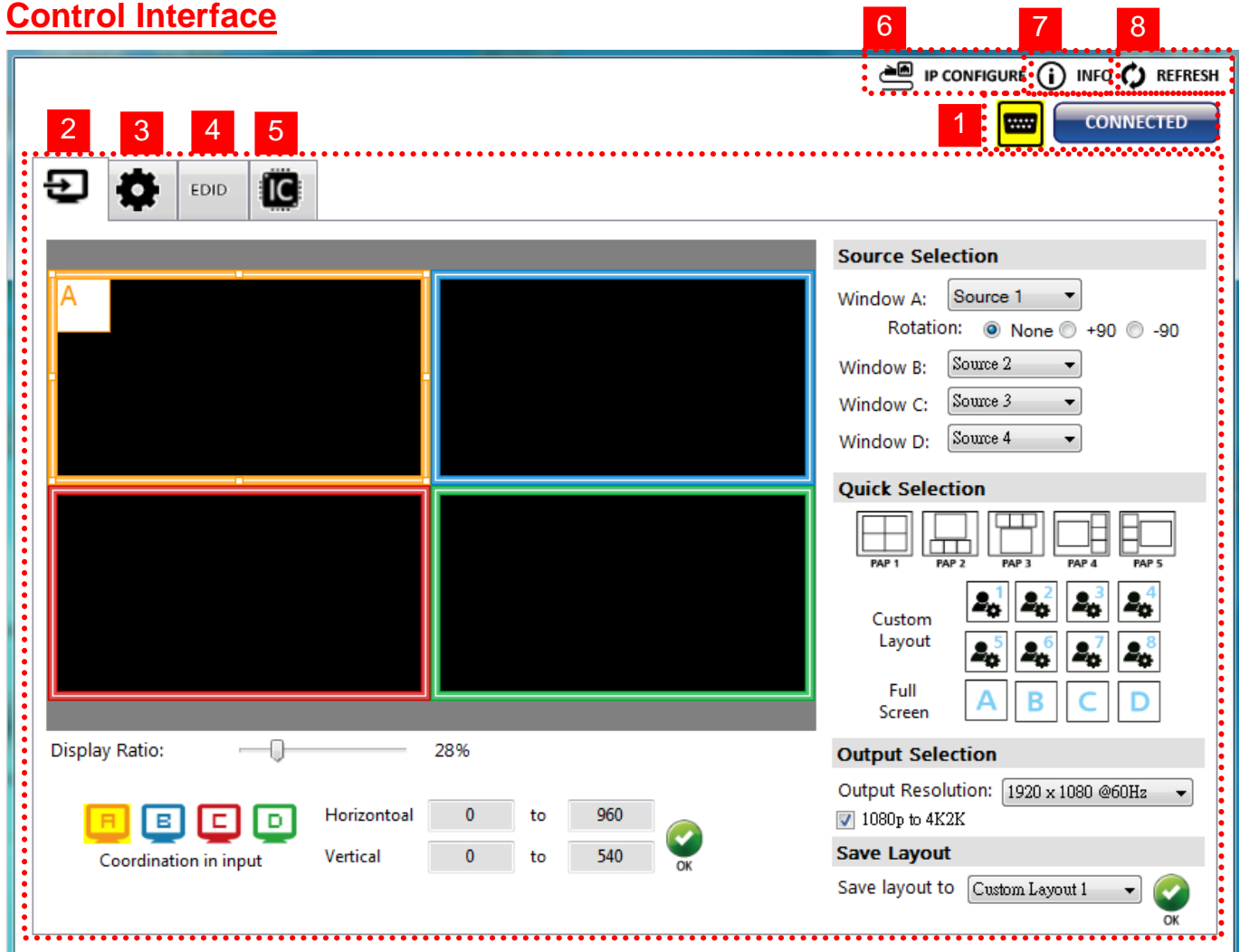

1. Connection Status:

Show the connect information and status. If users use RS-232 serial Mode to connect device, the graph is . In contrast, the graph of Ethernet is . In addition, if users would like to change the control method, users can click on the button to change.

2. Output Settings

In this section, users can set up the coordinate for inputs, the source of window A~D, output resolution, PAP layout setting and input rotation.

(1) Source Selection

For each display window, you can assign arbitrary video source here.

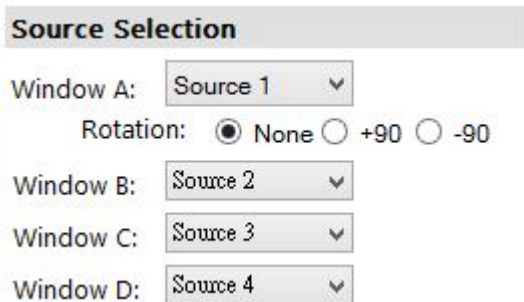

(2) Quick Selection

We provide 9 default modes and 8 custom modes for you to select.

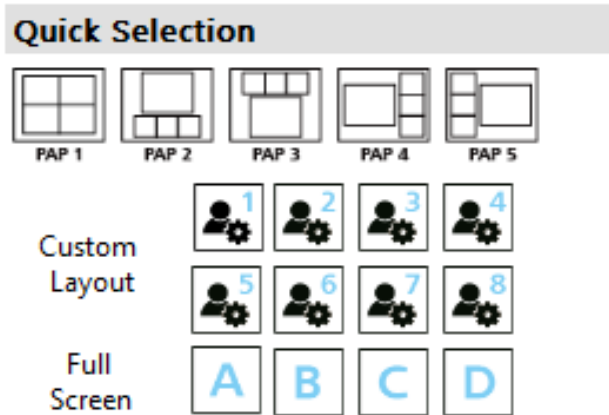

(3) Output Resolution

Set the output resolution. If user click the 1080p to 4K2K function, when output resolution is 1920 x 1080 @60Hz, it will upscale the resolution to 4K2K.

*In 4K2K@60Hz resolution, the output display will be forced to PAP 1 () layout (other PAP layout cannot set) and only can set up the output resolution, sound and background function.

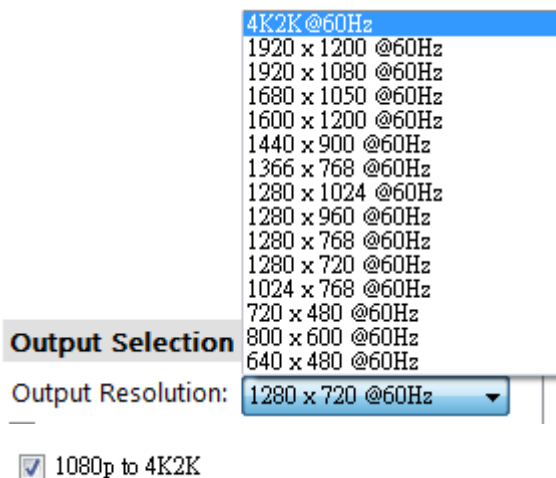

(4) Save Layout

We provide 8 custom layout space for users to save the frequently used scenarios into the flash memory.

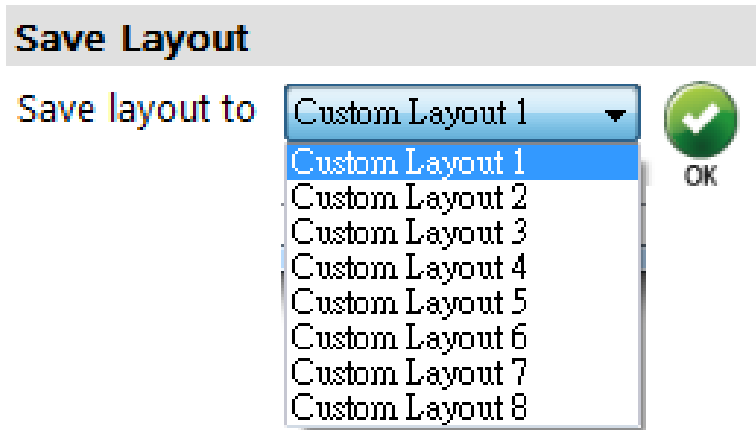

(5) Display Panel

In the left part of control interface, user can customize the display mode thru control. The different colors of frame represent the different input windows. The information of coordinate shows the position of input source screen. In addition, we provide display ratio for users to set the display panel sizes.

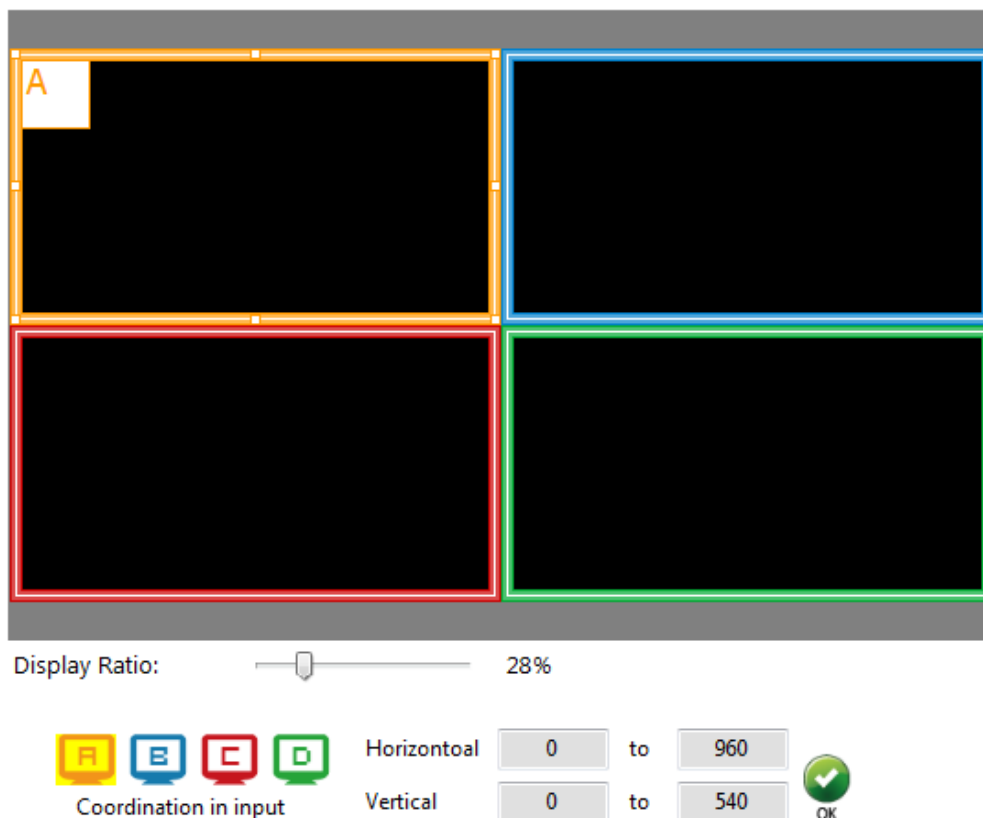

3. Advanced Setting

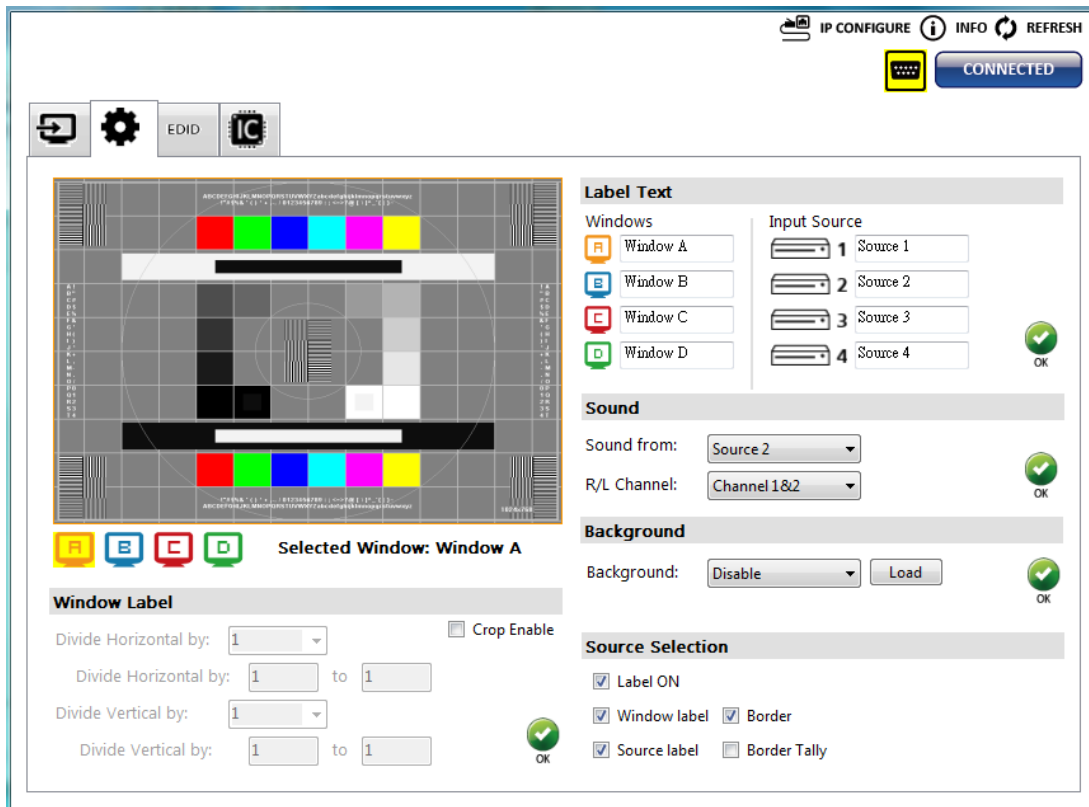

(1) Window settings

In this mode, user can adjust individual display area for selected input sources. Firstly, user have to choose the specific channel A, B, C, or D, which are presented as in the control panel as shown. After the specific channel is chosen, user can crop the display area of that particular channel at will and do the same to the rest of channels if necessary. The control panel of software can instantly give a quick shot on how those settings to be presented look like in the final outcome video.

(2) Label Text

In here, users can input the texts to be shown with the video.

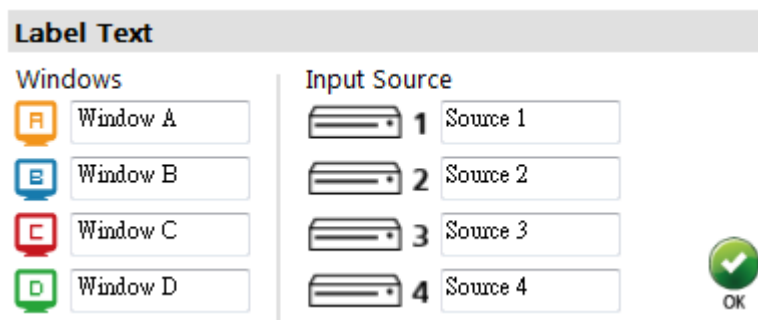

(3) Sound

To set up the audio source of the output and R/L channels.



(4) Background

To set up the background of window. We provide 4 default pictures for you to select. If you want to change default picture, you can click  button to select the picture which you want to change.

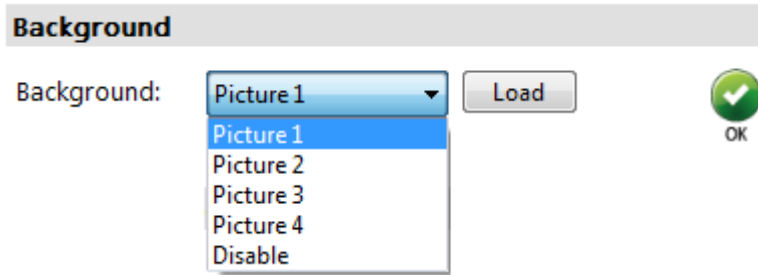

The interface shows a section titled "Background". Below the title, there is a label "Background:" followed by a dropdown menu currently showing "Picture 1". The dropdown menu is open, listing "Picture 1", "Picture 2", "Picture 3", "Picture 4", and "Disable". To the right of the dropdown is a "Load" button. Further right is a green circular "OK" button with a checkmark icon.

(5) Window Label

In this function, users can determine if the window's label/border is turned on or off.

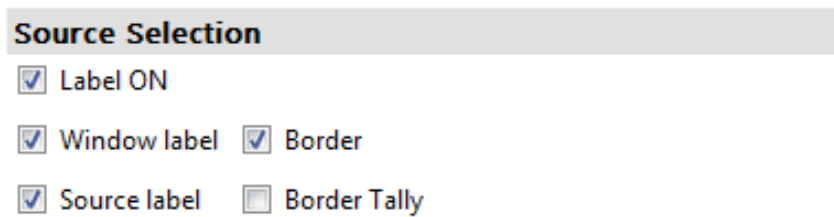

The interface shows a section titled "Source Selection". Below the title, there are four checkboxes: "Label ON" (checked), "Window label" (checked), "Border" (checked), "Source label" (checked), and "Border Tally" (unchecked).

4. EDID (Extended display identification data)

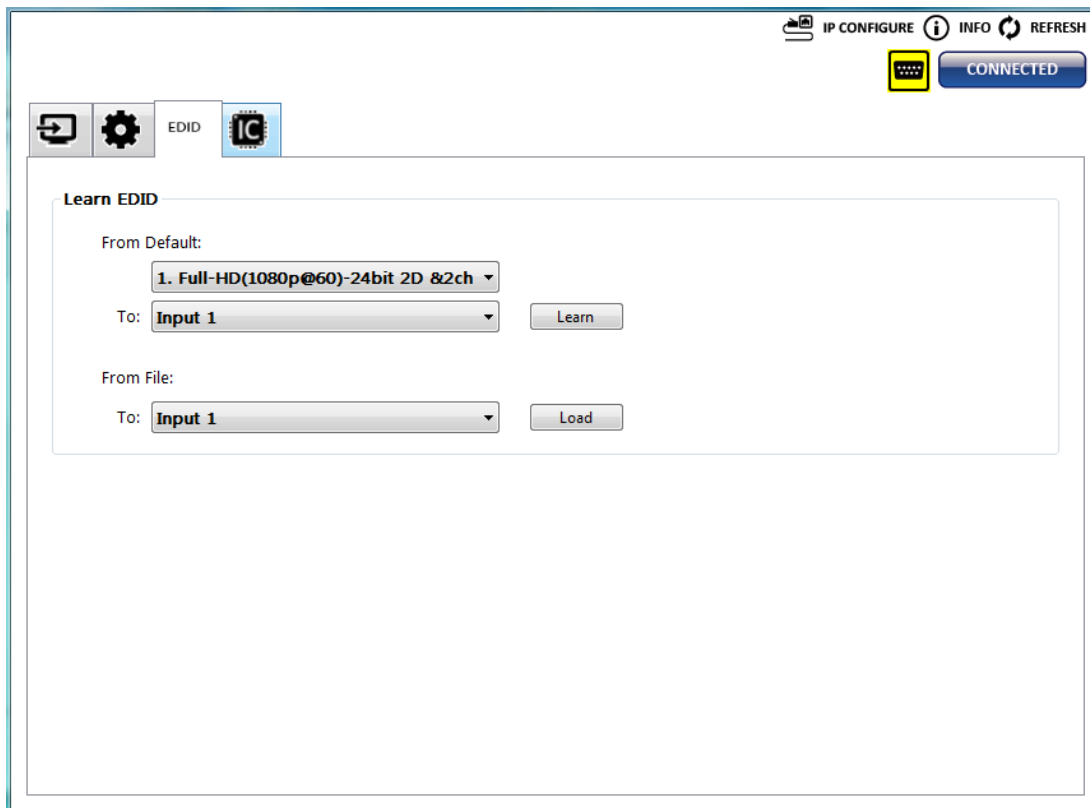

The interface shows the "EDID" configuration page. At the top right, there are links for "IP CONFIGURE", "INFO", and "REFRESH". Below these is a "CONNECTED" status indicator. The main content area is titled "Learn EDID" and contains two sections: "From Default:" and "From File:". The "From Default:" section has a dropdown menu showing "1. Full-HD(1080p@60)-24bit 2D 82ch" and a "To:" dropdown menu showing "Input 1", with a "Learn" button. The "From File:" section has a "To:" dropdown menu showing "Input 1" and a "Load" button.

(1) Learn EDID from Default

- Select Default EDID

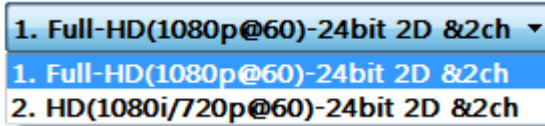

- Select Input

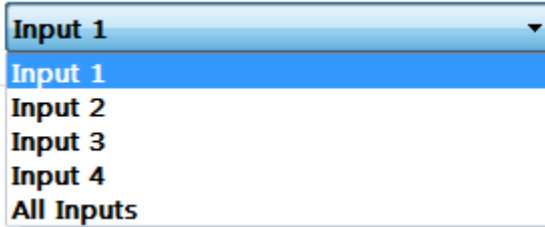

- Click button to learn default EDID.

(2) Learn EDID from File

- Select input
- Click button to select the EDID file and write it into input

5. System Setting

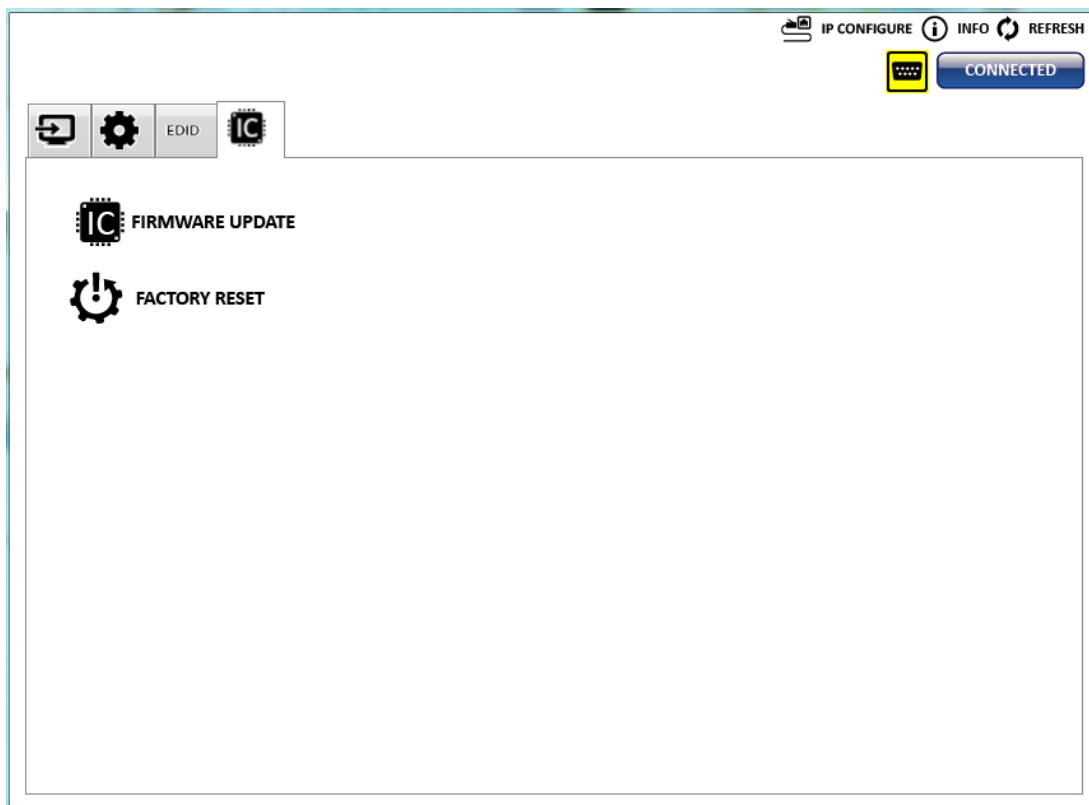

(5) Firmware Update

- Click  FIRMWARE UPDATE button to do firmware update.
- The “Firmware update” window shows up as below.

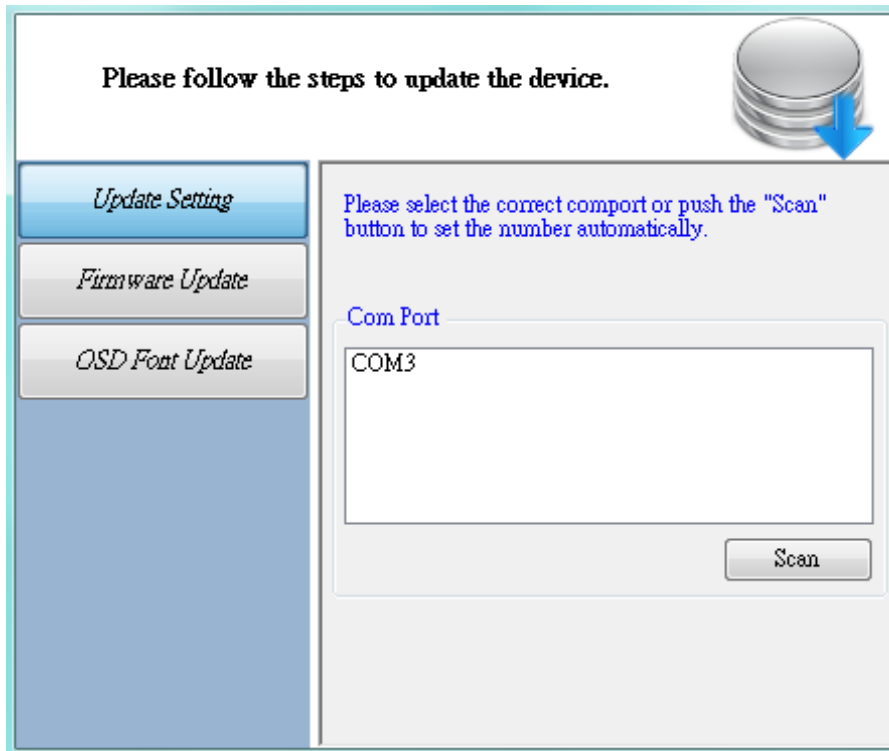

- Please select the correct COM port or click “Scan” button to connect device.
- Click “update” button to do firmware update.

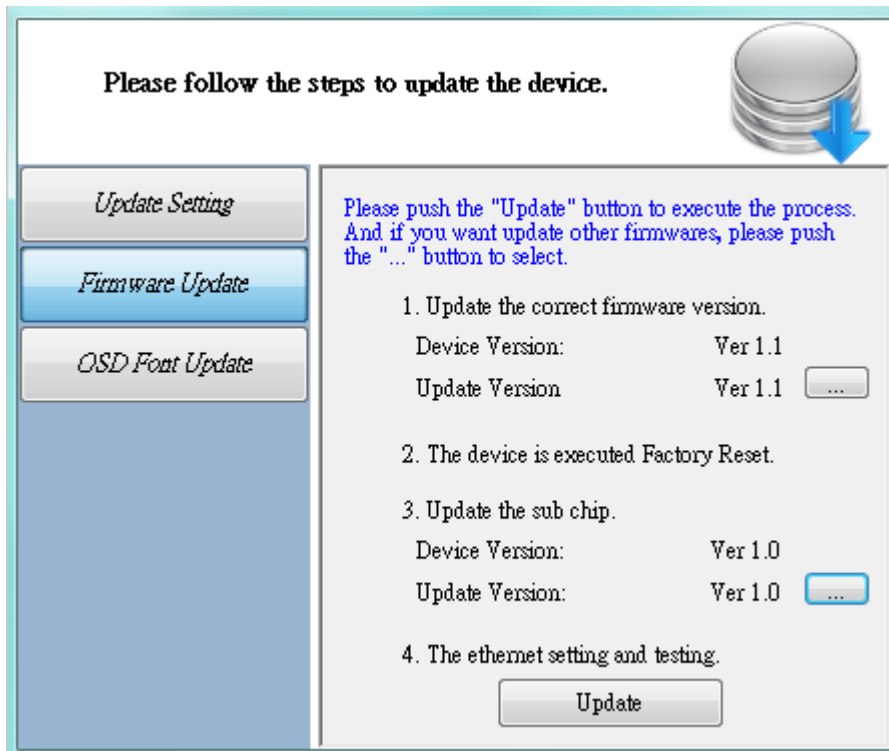

- If you want to change OSD (window label) font, please click “OSD Font Update” and “update” buttons to change OSD font.

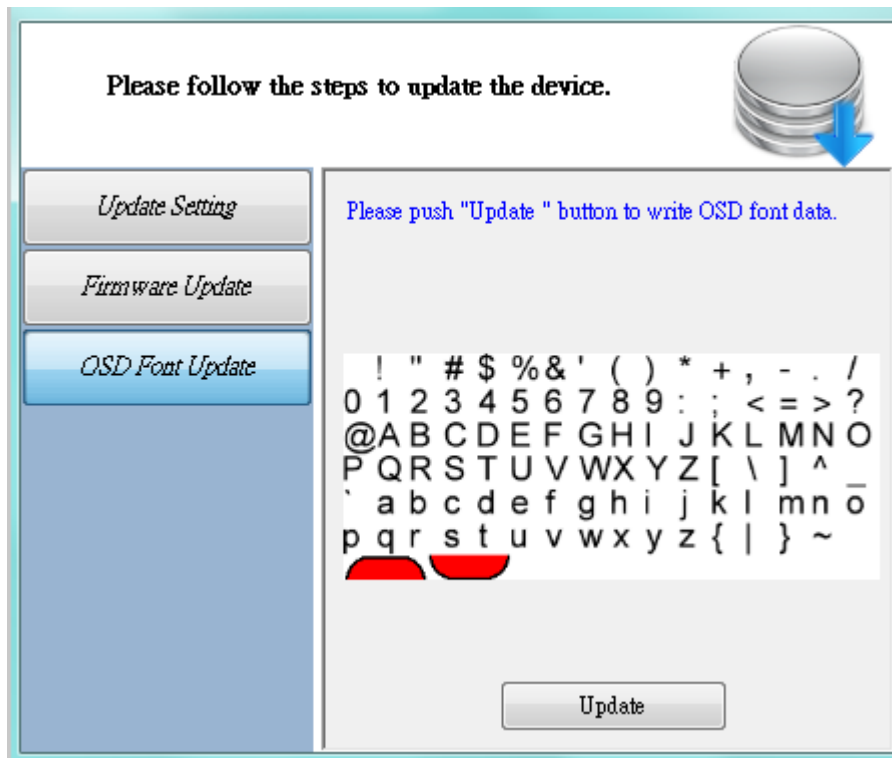

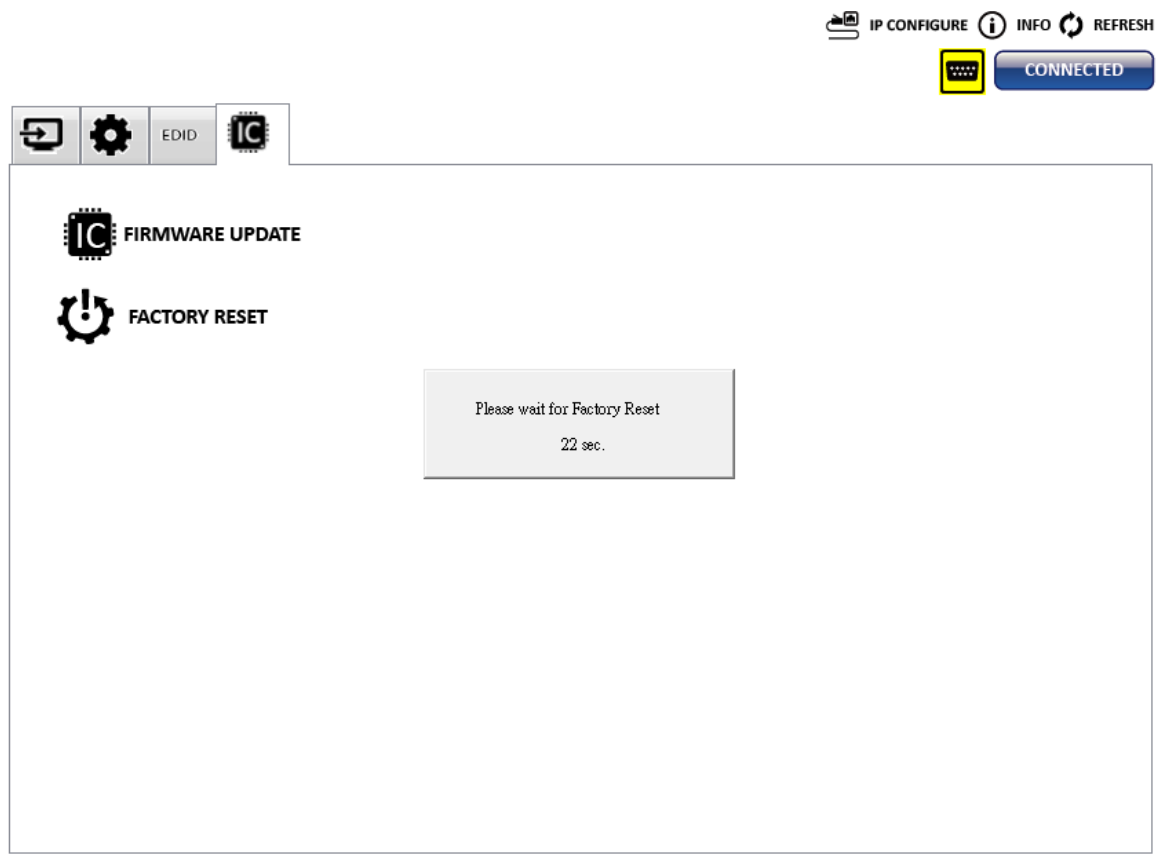

(5) Factory Reset

- Click  **FACTORY RESET** button to do factory default reset.
- The process of default reset will take about 25 seconds.



6. IP Configure

User also can use the Ethernet to control the mixer. Firstly, user should click on the  **IP CONFIGURE** button to setup network set. Next, users can setup the Ethernet for the unit as below example shows. After the step of IP configuration, please click the  button.

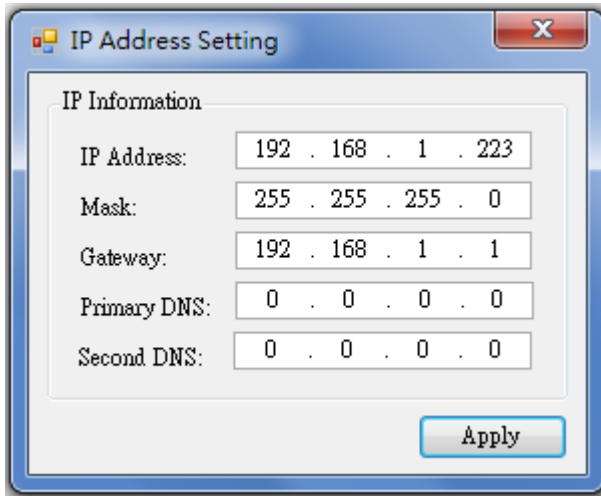

7. Info

Read the Software and firmware version.

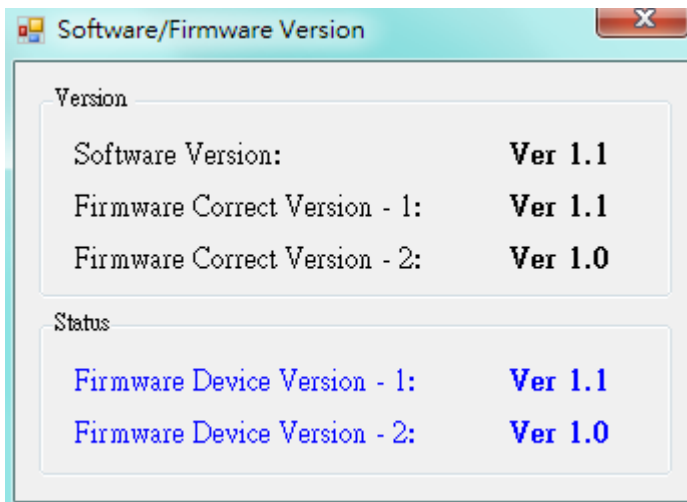

***Software/firmware information subject to change without notification.**

8. Refresh

This function can get all information of the device and update this software state.

WARRANTY

The SELLER warrants the **MX-5004MZF 4x1 HDMI 2.0a Quad-View Video Processor with 4K2K60 4:4:4** free from defects in the material and workmanship for 1 year from the date of purchase from the SELLER or an authorized dealer. Should this product fail to be in good working order within 1 year warranty period, The SELLER, at its option, repair or replace the unit, provided that the unit has not been subjected to accident, disaster, abuse or any unauthorized modifications including static discharge and power surge. This warranty is offered by the SELLER for its BUYER with direct transaction only. This warranty is void if the warranty seal on the metal housing is broken.

Unit that fails under conditions other than those covered will be repaired at the current price of parts and labor in effect at the time of repair. Such repairs are warranted for 90 days from the day of reshipment to the BUYER. If the unit is delivered by mail, customers agree to insure the unit or assume the risk of loss or damage in transit. Under no circumstances will a unit be accepted without a return authorization number.

The warranty is in lieu of all other warranties expressed or implied, including without limitations, any other implied warranty or fitness or merchantability for any particular purpose, all of which are expressly disclaimed.

Proof of sale may be required in order to claim warranty. Customers outside Taiwan are responsible for shipping charges to and from the SELLER. Cables and power adapters are limited to a 30 day warranty and must be free from any markings, scratches, and neatly coiled.

The content of this manual has been carefully checked and is believed to be accurate. However, The SELLER assumes no responsibility for any inaccuracies that may be contained in this manual. The SELLER will NOT be liable for direct, indirect, incidental, special, or consequential damages resulting from any defect or omission in this manual, even if advised of the possibility of such damages. **Also, the technical information contained herein regarding the MX-5004MZF features and specifications is subject to change without further notice.**